

PLAN VIEW

1

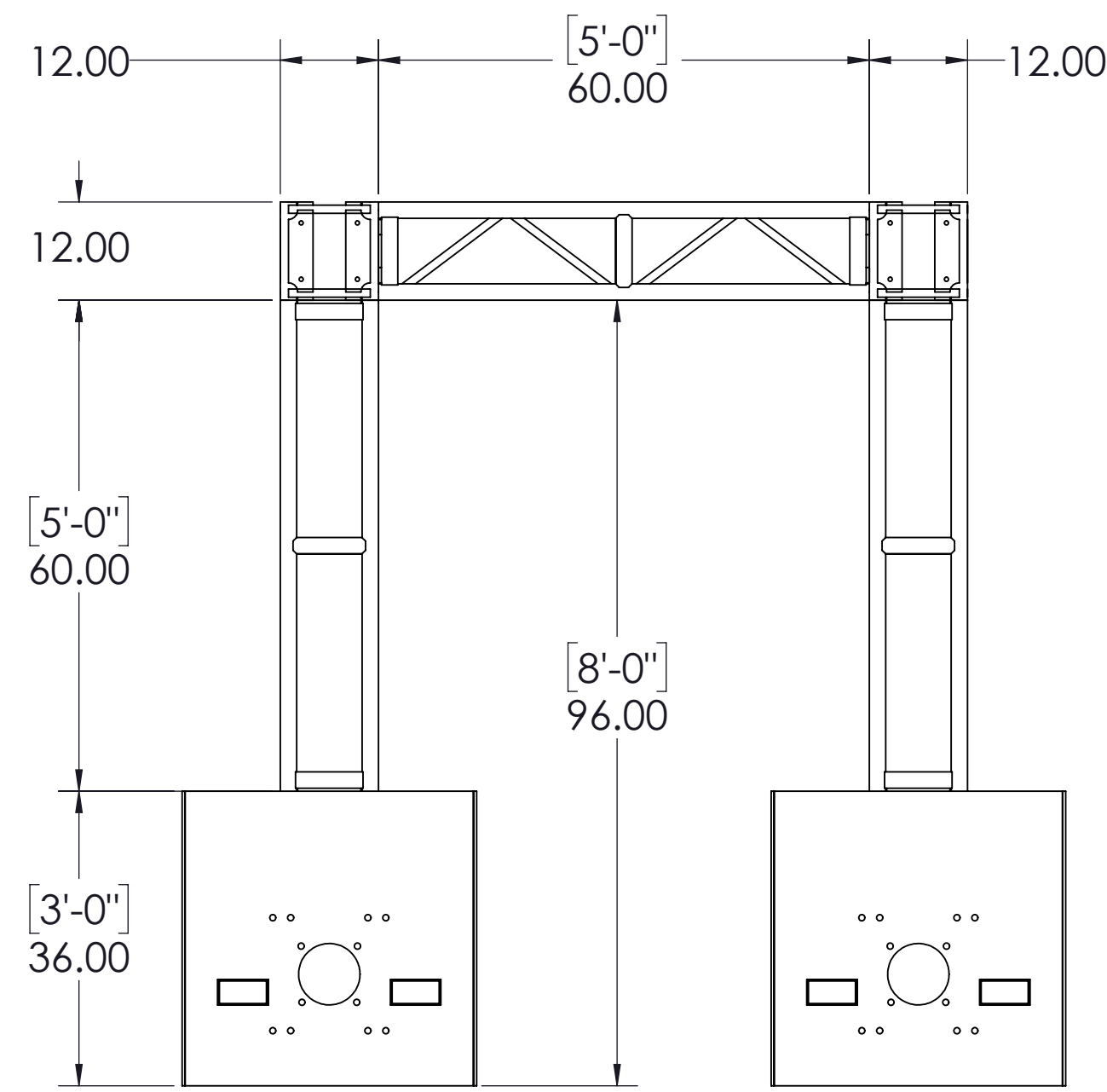

FRONT ELEVATION VIEW

2

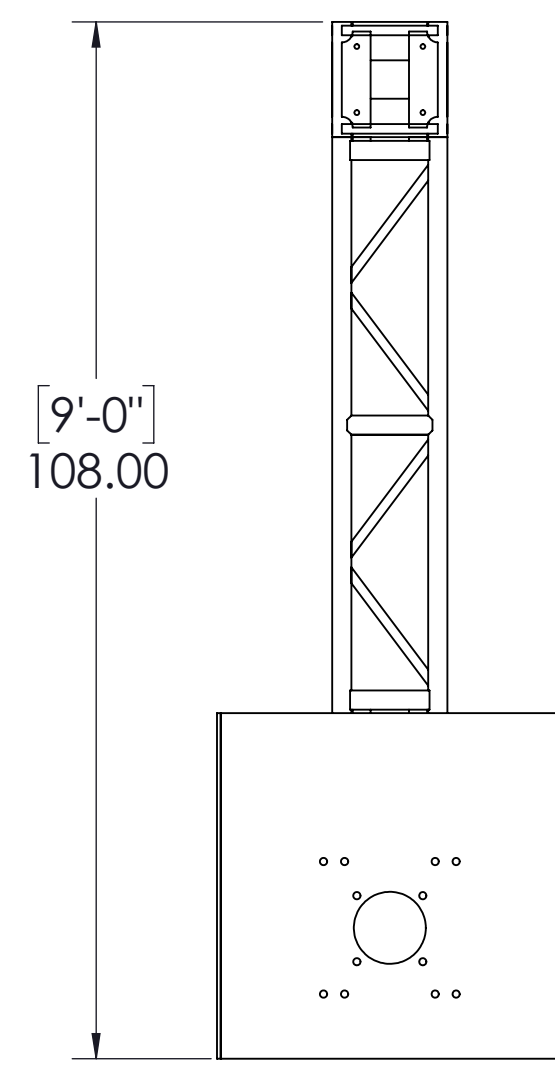

SIDE ELEVATION VIEW

3

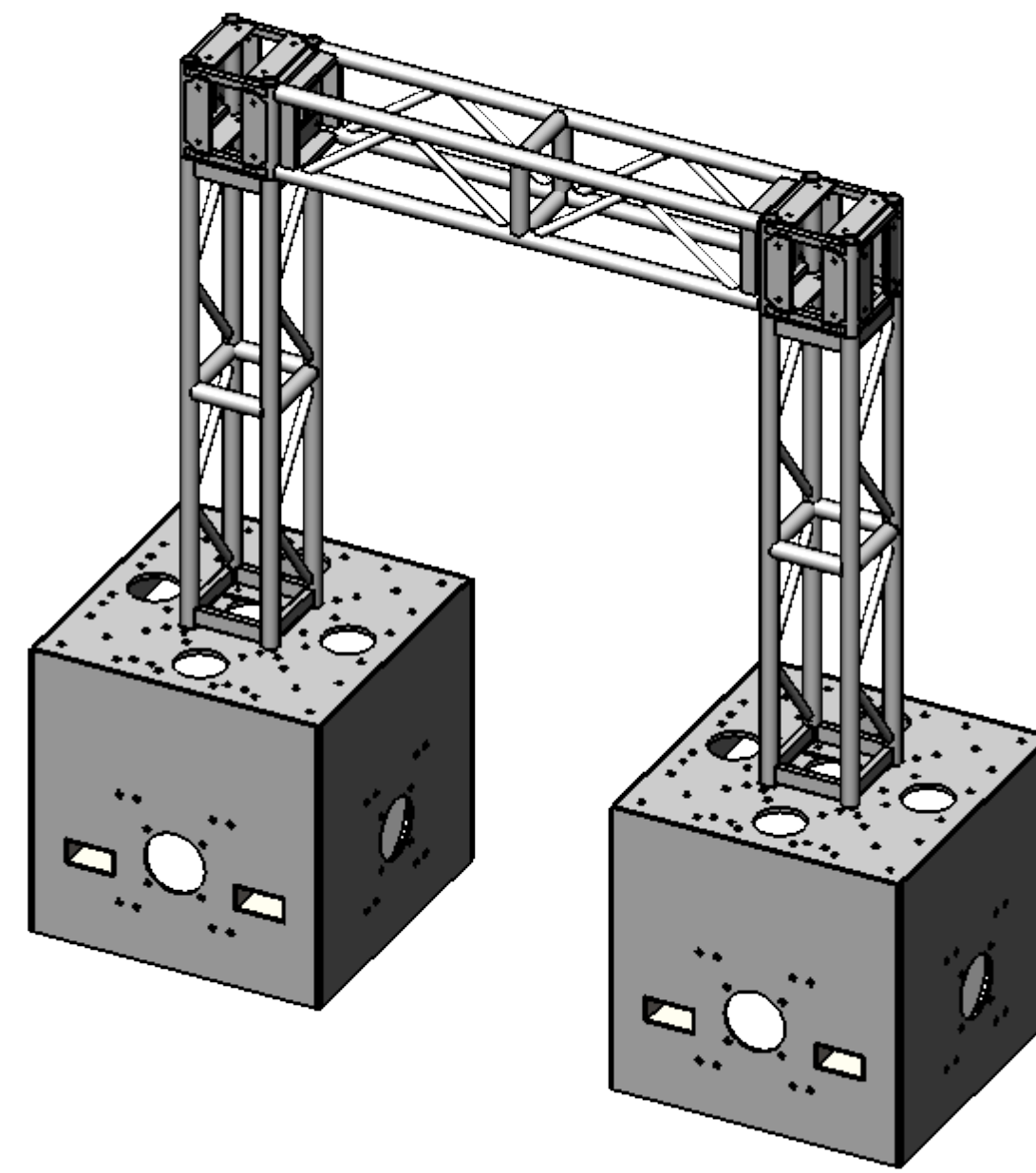

NOTES: UNLESS OTHERWISE SPECIFIED

THIS DRAWING IS PROPERTY OF GALLAGHER STAGING AND PRODUCTIONS AND CANNOT BE DUPLICATED, MODIFIED OR USED FOR ANY OTHER PURPOSE WITHOUT WRITTEN PERMISSION FROM GALLAGHER STAGING. USE OF THIS DRAWING FOR BIDDING IS STRICTLY PROHIBITED. VERIFY ALL DIMENSIONS, SPECIFICATIONS, AND CONDITIONS BEFORE USING THIS DRAWING FOR CONSTRUCTION. THIS DRAWING IS CONFIDENTIAL AND SHOULD NOT BE DISCLOSED TO A 3RD PARTY WITHOUT WRITTEN PERMISSION FROM GALLAGHER STAGING AND PRODUCTIONS.



GALLAGHER STAGING & PRODUCTIONS ♦ 15701 HERON AVE ♦ LA MIRADA, CA 90638

PROJECT NAME: GALLAGHER 12IN TRUSS ARCH

DRAWING TITLE: GALLAGHER 12IN TRUSS ARCH - 8FTX5FT ID

PROJECT NUMBER:

DRAWN BY: AARON SANCHEZ

DATE: 07/21/2016

REVISION: V1

SCALE: 1 TO 20
ON 11 X 17 PAGE

SHEET: 1 OF 1